

Features:

- Current transfer ratio
(CTR:MIN.50% at $I_F = 5\text{mA}$, $V_{CE} = 5\text{V}$)
- High isolation voltage between input and output ($V_{iso} = 5000\text{V}_{rms}$)
- Compact dual-in-line package
SL-816 :1-channel type
- Pb free

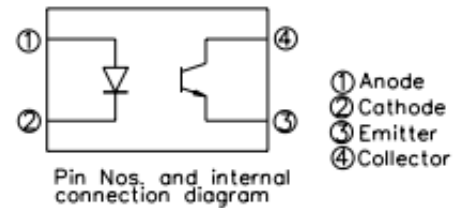

Description

The SL816 series contains a infrared emitting diode optically coupled to a phototransistor. It is packaged in a 4-pin DIP and SMD .

Applications

- Computer terminals
- System appliances, measuring instruments
- Registers, copiers, automatic vending machines
- Cassette type recorder
- Electric home appliances, such as fan heaters, etc.
- Signal transmission between circuits of different potentials and impedances

Absolute Maximum Ratings

($T_a = 25^\circ\text{C}$)

Parameter		Symbol	Rating	Unit
Input	Forward Current	I_F	50	mA
	Reverse Voltage	V_R	6	V
	Power Dissipation	P	70	mW
Output	Collector Power Dissipation	P_C	150	mW
	Collector Current	I_C	50	mA
	Collector-Emitter Voltage	V_{CEO}	80	V
	Emitter-Collector Voltage	V_{ECO}	6	V
Total Power Dissipation		P_{tot}	200	mW
Isolation Voltage		V_{iso}	5000	V_{rms}
Operating Temperature		T_{opr}	-55~+110	$^\circ\text{C}$
Storage Temperature		T_{stg}	-55~+125	$^\circ\text{C}$
Soldering Temperature		T_{sol}	260	$^\circ\text{C}$

Electro-Optical Characteristics

(Ta=25°C)

25°C) Parameter		Symbol	Min.	Typ.	Max.	Unit	Condition
Input	Forward Voltage	V_F	-	1.2	1.4	V	$I_F=20\text{mA}$
	Reverse Current	I_R	-	-	10	μA	$V_R=4\text{V}$
	Terminal Capacitance	C_t	-	30	250	pF	$V=0, f=1\text{kHz}$
Output	Collector Dark current	I_{CEO}	-	-	100	nA	$V_{CE}=20\text{V}$
	Collector-Emitter Breakdown Voltage	BV_{CEO}	80	-	-	V	$I_C=0.1\text{mA}$
Transfer Characteristics	Current Transfer Ratio	CTR	50	-	600	%	$I_F=5\text{mA}, V_{CE}=5\text{V}$
	Collector-Emitter Saturation Voltage	$V_{CE(sat)}$	-	0.1	0.2	V	$I_F=20\text{mA}, I_C=1\text{mA}$
	Isolation Resistance	R_{ISO}	5×10^{10}	10^{11}	-	Ω	DC500V, 40~60% R.H.
	Floating Capacitance	C_f	-	0.6	1.0	pF	$V=0, f=1\text{MHz}$
	Cut-off Frequency	f_c	-	80	-	kHz	$V_{CE}=5\text{V}, I_C=2\text{mA}$ $R_L=100\Omega, -3\text{dB}$
	Rise time	t_r	-	4	18	μs	$V_{CE}=2\text{V}$ $I_C=2\text{mA}, R_L=100\Omega$
	Fall time	t_f	-	3	18	μs	

Supplement

Rank Table of Current Transfer Ratio CTR

Model No.	Rank mark	CTR (%)	Condition
SL816S/X	---	50 to 600	$I_F = 5 \text{ mA}$ $V_{CE} = 5 \text{ V}$ $T_a = 25^\circ\text{C}$
SL816S/X (A)	A	50 to 160	
SL816S/X (B)	B	130 to 260	
SL816S/X (C)	C	200 to 400	
SL816S/X (D)	D	300 to 600	
SL816S/X (X)	X	100 to 200	
SL816S/X (Y)	Y	150 to 300	

Fig. 1 Forward Current vs. Ambient Temperature

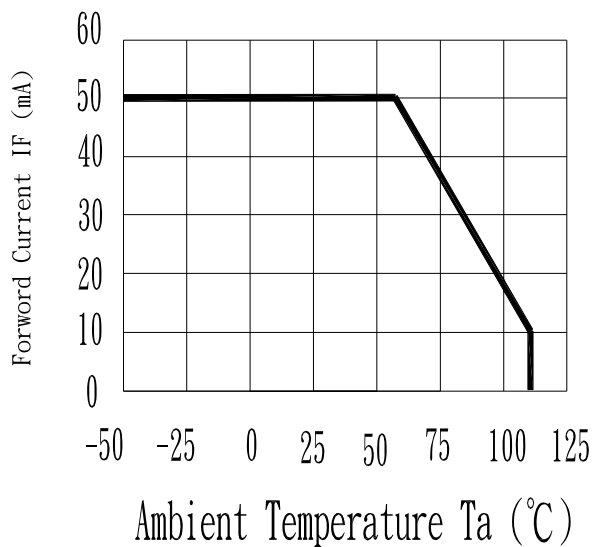

Fig.2 Collector Power Dissipation vs. Ambient Temperature

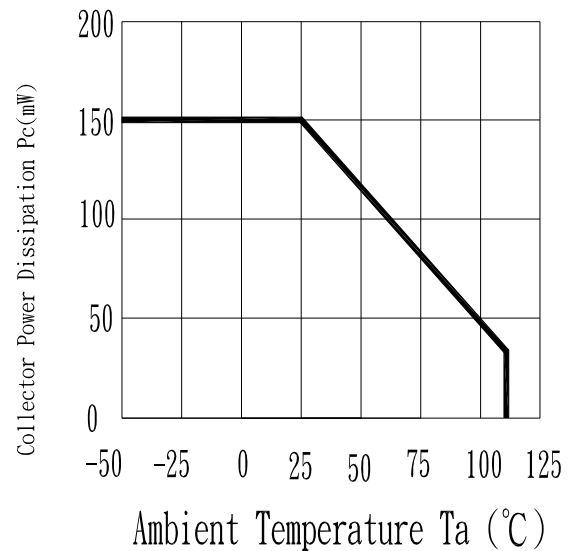

Fig. 3 Collector-emitter Saturation Voltage vs. Forward Current ($T_a=25^\circ\text{C}$)

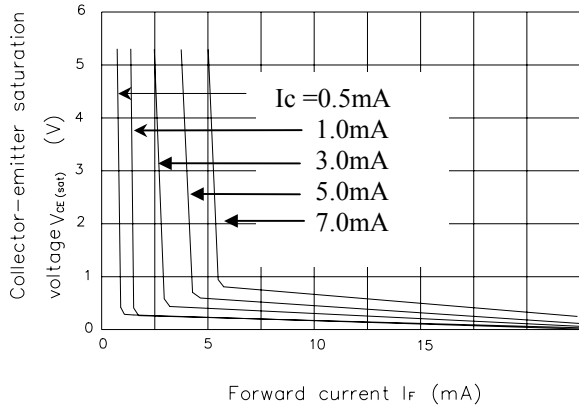

Fig. 4 Current transfer Ratio vs. Forward Current

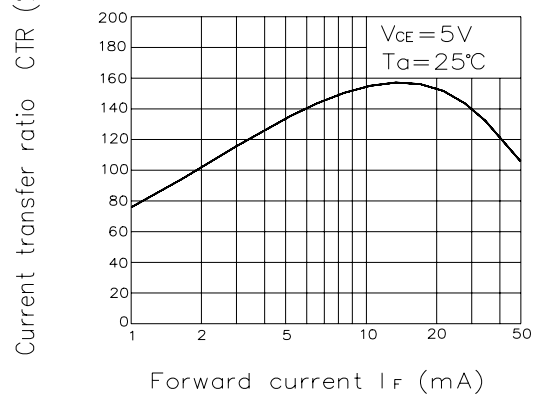

Fig. 5 Forward Current vs. Forward Voltage

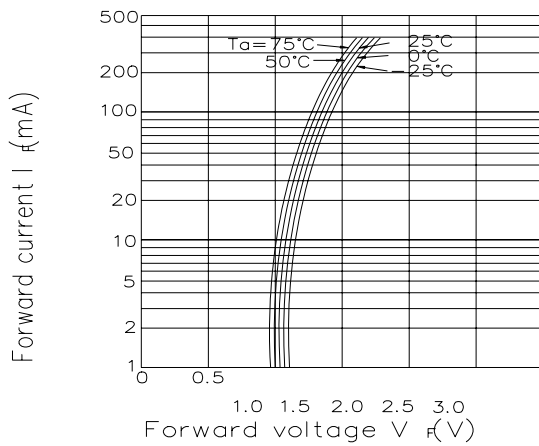

Fig. 6 Collector Current vs. Collector-emitter Voltage ($T_a=25^\circ\text{C}$)

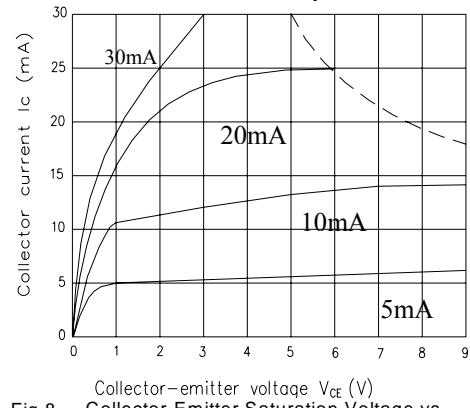

Fig. 7 Relative Current Transfer Ratio vs. Ambient Temperature

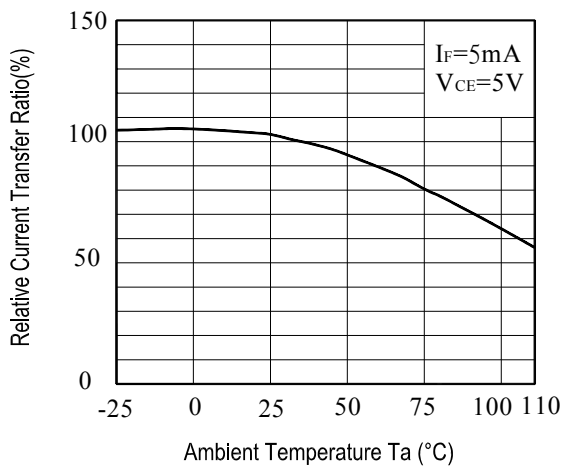

Fig. 8 Collector-Emitter Saturation Voltage vs. Ambient Temperature

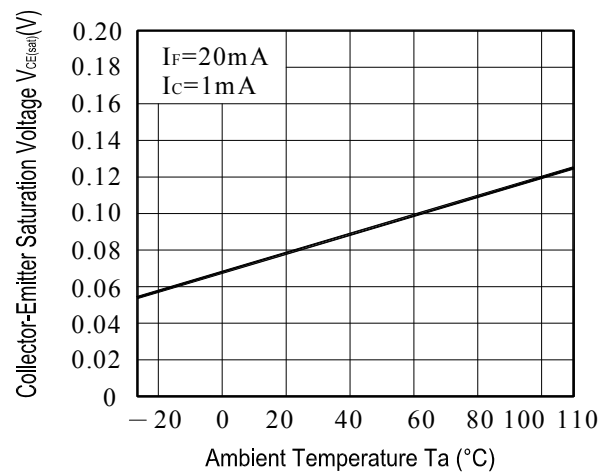

Fig.9 Collector Dark Current vs. Ambient Temperature

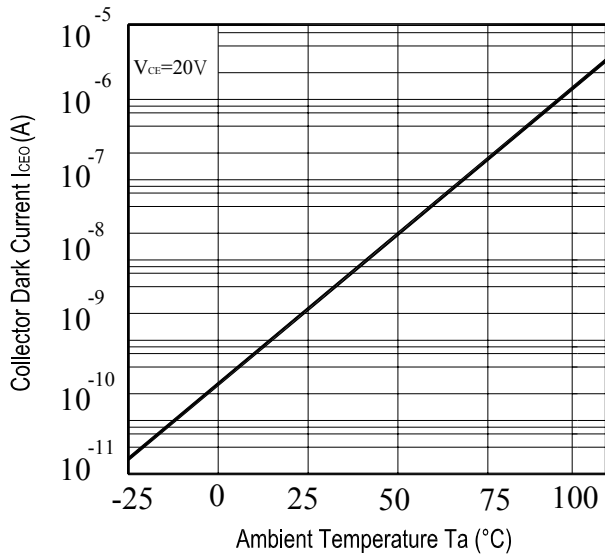

Fig.10 Response Time vs. Load Resistance

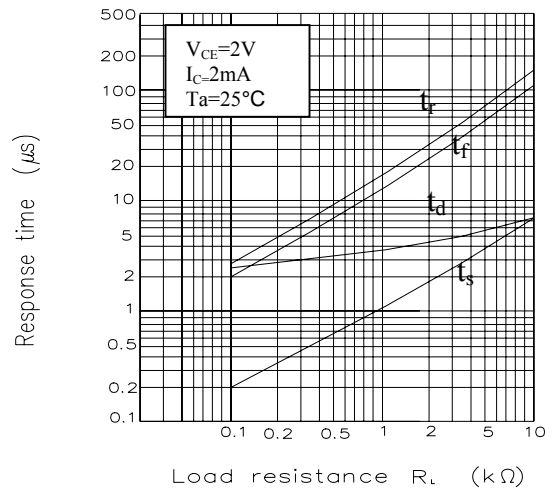
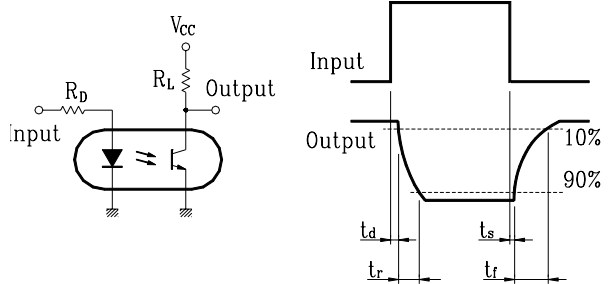
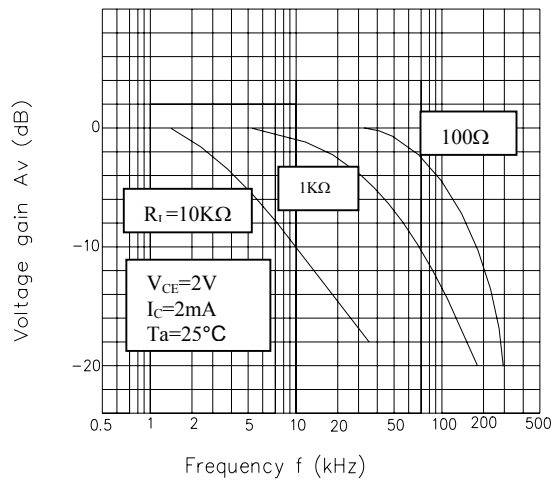
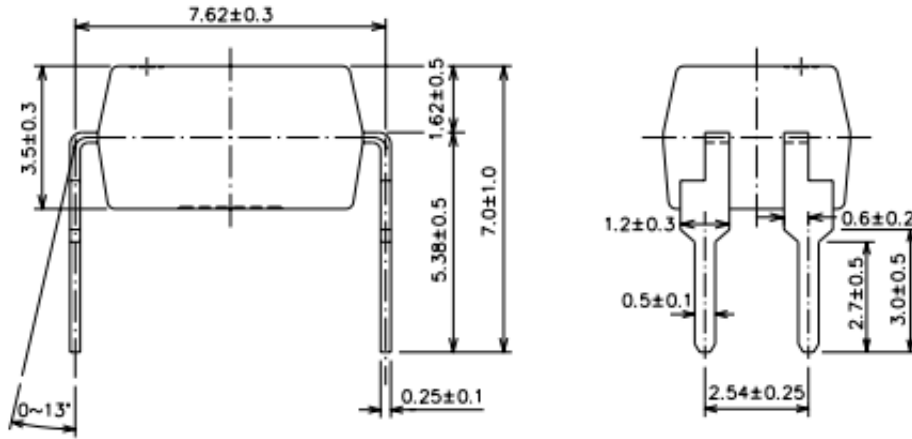

Fig.11 Frequency Response



Package Dimensions

DIP-4



SMD-4

